

Type H3 Load Cell



Short description



- Nickel plated alloy steel IP67 "S" type load cell
- Tension and compression applications
- Suitable for hanging, hopper and other weighing devices
- Also available in imperial capacities and dimensions

 OIML test certificate no. D09-03.18 Revision 2
C of C no R60/2000-CNI-00.01

 Certificate no. 06-099A1

Available models

Capacity	Accuracy	Full article description
25kg	C3 Excluded from OIML	H3-C3-25kg-3B
50kg	C3 Excluded from OIML	H3-C3-50kg-3B
100kg	C3/C4	H3-C3/C4-100kg-3B
150kg	C3/C4	H3-C3/C4-150kg-3B
200kg	C3/C4	H3-C3/C4-200kg-3B
250kg	C3/C4	H3-C3/C4-250kg-3B
300kg	C3/C4	H3-C3/C4-300kg-3B
500kg	C3/C4	H3-C3/C4-500kg-3B
600kg	C3/C4	H3-C3/C4-600kg-3B
750kg	C3/C4	H3-C3/C4-750kg-3B
1t	C3/C4	H3-C3/C4-1t-3B
1.5t	C3/C4	H3-C3/C4-1.5t-3B
2t	C3/C4	H3-C3/C4-2t-6B
2.5t	C3/C4	H3-C3/C4-2.5t-6B
3t	C3 Excluded from OIML	H3-C3-3t-6B
5t	C3 Excluded from OIML	H3-C3-5t-6B
7.5t	C3 Excluded from OIML	H3-C3-7.5t-6B
10t	C3 Excluded from OIML	H3-C3-10t-6B
15t	C3 Excluded from OIML	H3-C3-15t-6B
20t	C3 Excluded from OIML	H3-C3-20t-6B
30t	C3 Excluded from OIML	H3-C3-30t-6B

Specifications and dimensions are subject to change without notice and do not constitute any liability whatsoever.

Type H3 Load Cell

Detailed specifications H3

Accuracy class		OIML R60 C3	OIML R60 C4	C3
Output sensitivity (= FS)	mV/V	2.0 ± 0.004		
Maximum capacity (E _{max})	t	0.1, 0.15, 0.2, 0.25, 0.3, 0.5, 0.6, 0.75, 1, 1.5, 2, 2.5		0.025, 0.05, 3.0, 5.0, 7.5, 10, 15, 20, 30
Max.number of load cell intervals	n _{LC}	3000	4000	3000
Ratio of min. LC verification interval	$Y = E_{max} / v_{min}$	10000	20000	10000
Combined Error	%FS	≤± 0.020	≤± 0.018	≤± 0.020
Minimum dead load	Of E _{max}	0%		
Safe overload	of E _{max}	150 %		
Ultimate overload	of E _{max}	300 %		
Zero balance	of FS	< ± 1.5 %		
Excitation, recommended voltage	V	5 ~ 12		
Excitation maximum	V	18		
Input resistance	Ω	350 ± 3.5		
Output resistance	Ω	351 ± 2.0		
Insulation resistance	MΩ	≥5000 (at 50VDC)		
Compensated temperature	°C	-10 ~ +40		
Operating temperature	°C	-35 ~ +65		
Storage temperature	°C	-40 ~ +70		
Element material		Nickel plated alloy steel		
Ingress Protection (acc. to EN 60529)		IP67		
Recommended torque on fixation	Nm	M8:25 M10: 50 M12:75 M20:450 M33:750	M42:1450	
ATEX classification (optional)		II1G Ex ia II1C T4	II1D Ex iaD 20 T73°C	II3G nL IIC T4

Wiring

Wiring:

Shielded, 4 conductor cable.

Cable diameter: Ø5mm

Standard cable length for 25kg – 1.5t: 3m and for 2t – 30t: 6m.

Shield not connected to element.

4-wire diagram

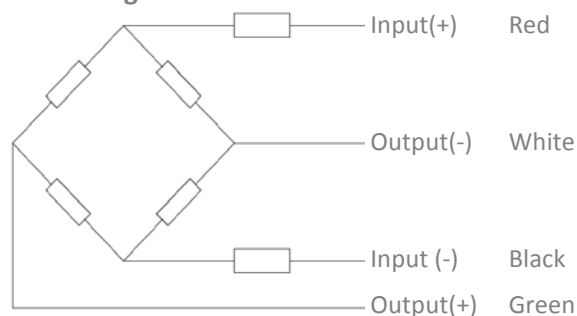

Specifications and dimensions are subject to change without notice and do not constitute any liability whatsoever.

Dimensions in mm

25kg–5t 0.1–20Klb

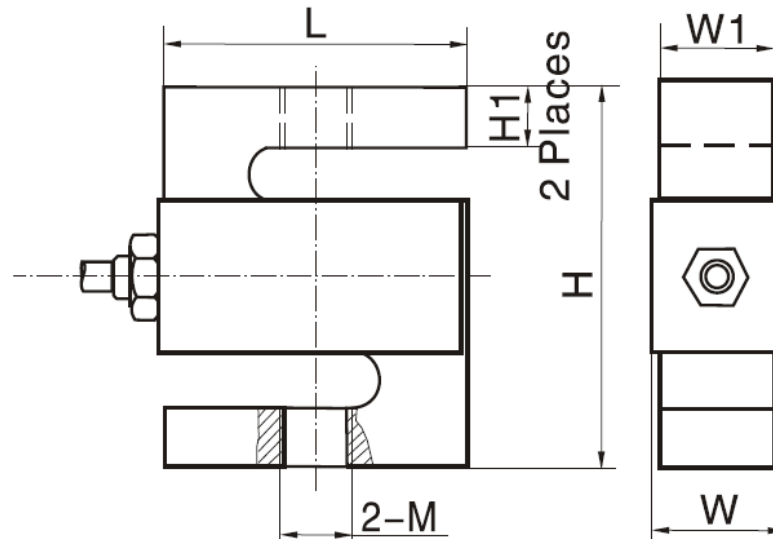

7.5t–30t

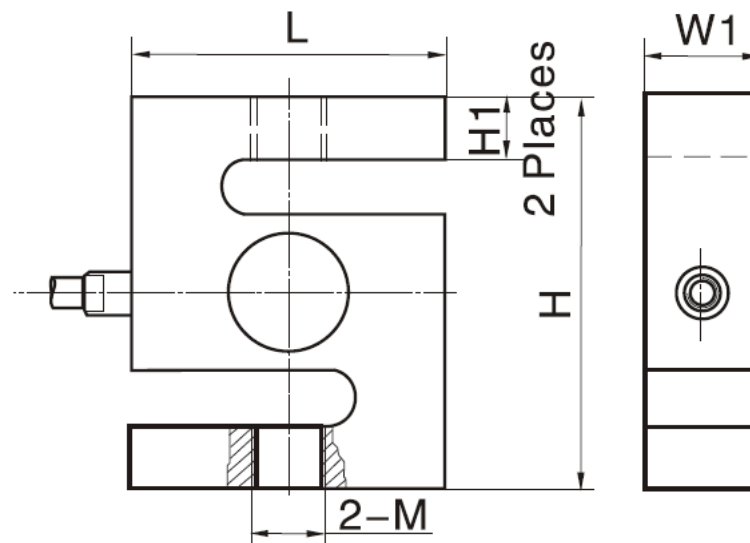

Dimension Capacity	L	H	W1	W	H1	M
25-50kg	50.8	76.2	12.7	14.5	15.7	M8
100-150kg	50.8	76.2	19.0	20.8	15.3	M10 x 1.5
200-750kg	50.8	76.2	19.0	20.8	13.6	M12 x 1.75
1-1.5t	50.8	76.2	25.4	27.2	12.1	M12 x 1.75
2-5t	76.2	101.6	25.4	27.2	20	M20 x 1.5
7.5-10t	125	175	50	-	40.2	M33 x 3
15-20t	160	200	60	-	51	M42x 3
30t	190	230	80	-	57.5	M42 x 3

Specifications and dimensions are subject to change without notice and do not constitute any liability whatsoever.

Type H3 Load Cell

Available accessories

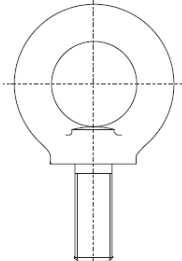
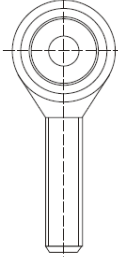
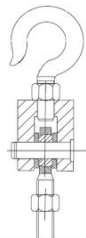
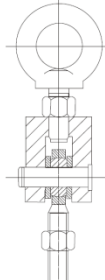
<p>HL-3-001-25kg-5t hook</p> <ul style="list-style-type: none">• Alloy Steel• Suitable for hybrid scales, crane scales, packaging scales and hopper scales	
<p>HL-3-002-25kg-5t eye</p> <ul style="list-style-type: none">• Alloy Steel• Suitable for hybrid scales, crane scales, packaging scales and hopper scales	
<p>HL-3-003-25kg-5t rod end</p> <ul style="list-style-type: none">• Alloy Steel• Suitable for hybrid scales, crane scales, packaging scales, hopper scales and other electronic weighing devices.	
<p>HL-3-004-25kg-5t hook assembly</p> <ul style="list-style-type: none">• Alloy Steel• Suitable for hybrid scales, crane scales, packaging scales, hopper scales and other electronic weighing devices.	
<p>HL-3-005-25kg-5t eye assembly</p> <ul style="list-style-type: none">• Alloy Steel• Suitable for hybrid scales, crane scales, packaging scales, hopper scales and other electronic weighing devices.	

Specifications and dimensions are subject to change without notice and do not constitute any liability whatsoever.